

# HOSPITAL MANAGEMENT SYSTEM PROJECT DOCUMENTATION

## Hospital Management System Project Abstract

This Hospital Management System project is a computerized hospital front desk management that produces user-friendly, quick, and cost-effective software. It handles and secures patient information, diagnosis data, and so on. This was done by hand and its' principal job is to register and maintain patient and doctor information and to access and update the information when needed. Patient information and diagnosis are entered into the system, then the output is used to display these details on the screen. A username and password are required to access the Hospital Management System. It can be accessed by a receptionist or an administrator. They are the only ones who have access to the database. The information is easily accessible. For personal usage, the data is well-protected, and the data processing is quick.

## Hospital Management System Project Modules:

- **Patient Management:** This module covers from the process of intake until discharge of an account of the patient's engagement with the health-care team. Communication, empathy, examination, evaluation, diagnosis, prognosis, and intervention are all part of the process.
- **Doctor/Physician Management:** The management of the physicians would be included in creating this system. Through this process, the admin will have the information and transactions made by the doctors with the patients.
- **Medicine and Prescription Management:** This module will handle the process of monitoring a patient's medications to verify that they are taken correctly and that the intended therapeutic outcome is achieved.
- **Online Appointment Management:** This process is a tool that helps hospital admin manage their appointments. Internet booking is one of the tools available in an appointment management solution. Booking with a mobile app.
- **Medical and Transaction Management:** Medical and transaction management modules aim to secure every transaction made by the patients and physicians in order to enhance healthcare quality and outcomes.
- **Payment and Expense Management:** Payment and expense management module id meant to assist the admin in the payment management process. This will help the hospital with the full payment processing and accounts payable process.

These modules must be present in creating the Hospital Management to satisfy the needs in managing Hospital transactions. Through this, the management and monitoring of patients would be much easier for both hospital admin and physicians.

# **Hospital Management System Project Proposal**

The **Hospital Management System Project Proposal** has the complete description of the project to be proposed. This contains the problem statement which discusses the difficulties that the hospital management faced and it is considered as the reason why the project is proposed. This proposal also includes the project scope that explains the boundaries and possible features of the project.

## **PROBLEM STATEMENT:**

Medical care is one of the most essential and in demand service for all. It requires a lot of attention and high-quality service that also causes health care workers to do a lot of effort. These issues also add the situations where there's a need for physical attendant for every patient wherein it could be automated and handled with technology.

## **SOLUTION:**

To address the issues faced by hospitals, a system named Hospital Management System is proposed. This system will handle information such as patients with mild diagnosis and prescriptions. The idea of having the automated patient management is a big help for our health care workers and physicians to monitor and take good care of the patients.

## **SCOPE:**

The hospital management system could handle specific task such as securing various information of the patients. This will help them secure the data to keep patient-doctor confidentiality as well as assure them of their healing factors. It can also improve the productivity of the, health care workers and could let them accommodate more patients.

# Hospital Management System Project Report: Diagrams

Here are the diagrams needed for hospital management system project report and its development.

[Hospital Management System Database Design](#) - The *Hospital management system database design* is a database design use for managing **hospital** functions and events. It enables the admin to register a patient for the hospital, stores their disease details into the database. Any of the staff members, doctor & admin is able to add, view, edit, update or delete data.

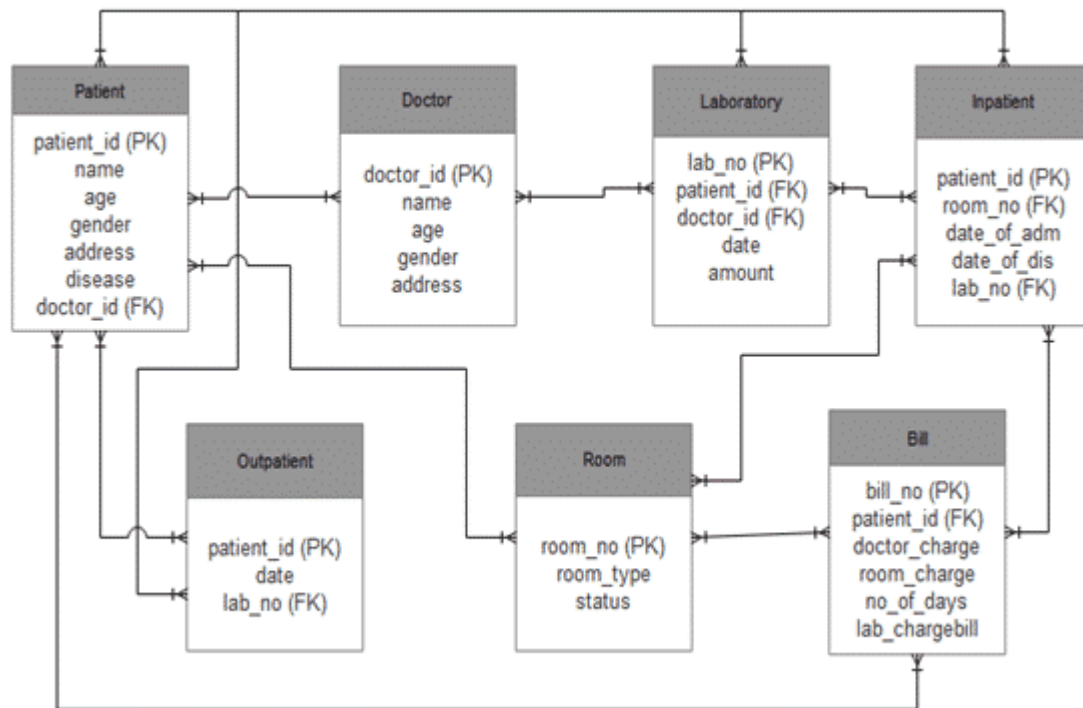

*Hospital Management System Database Design*

The purpose of the [Hospital Management System](#) database Design is to make a secure and easy way of storing information of the patient, doctors, inpatient, outpatient, Rooms, and Bill payment.

[Hospital Management System Use Case Diagram](#) - is a visual representation of how a user might interact with a program. A use case diagram depicts the system's numerous use cases and different sorts of users. The circles or ellipses are used to depict the use cases.

## HOSPITAL MANAGEMENT SYSTEM

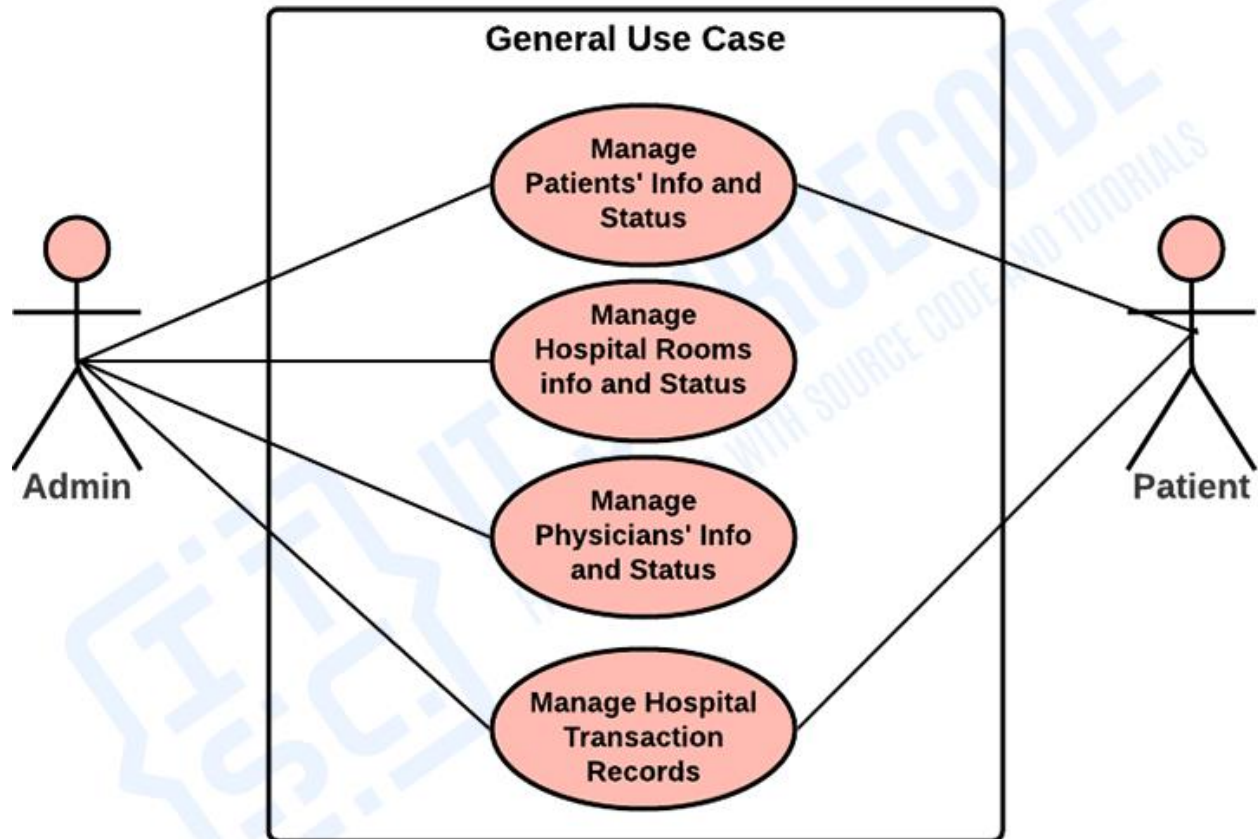

## USE CASE DIAGRAM

*Hospital Management System Use Case Diagram*

[Hospital Management System DFD Level 0 1 2](#) - will give you deep understanding about Hospital management system DFD levels 0, 1 and 2. This will teach you in managing [hospital information](#) as well as the flow of activities happens in [hospital management system](#).

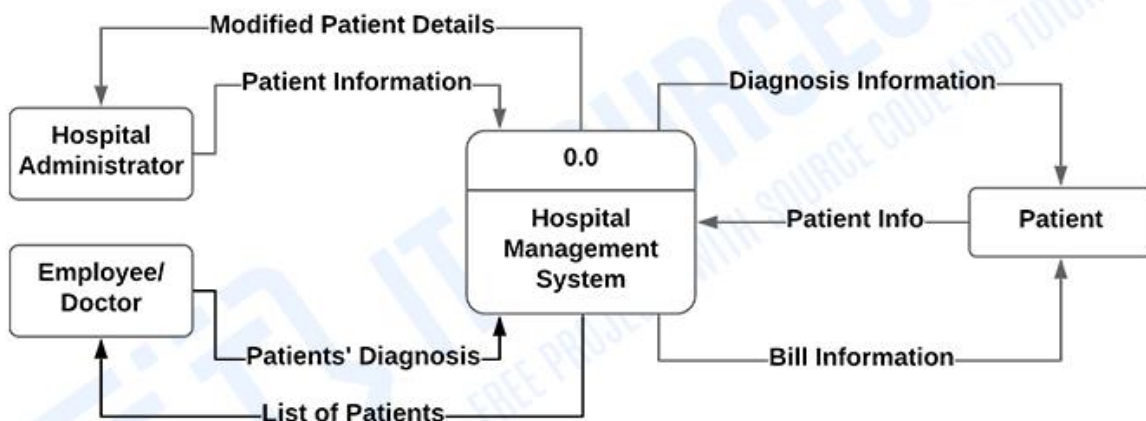

*Hospital Management System DFD Level 0 (Context Diagram)*

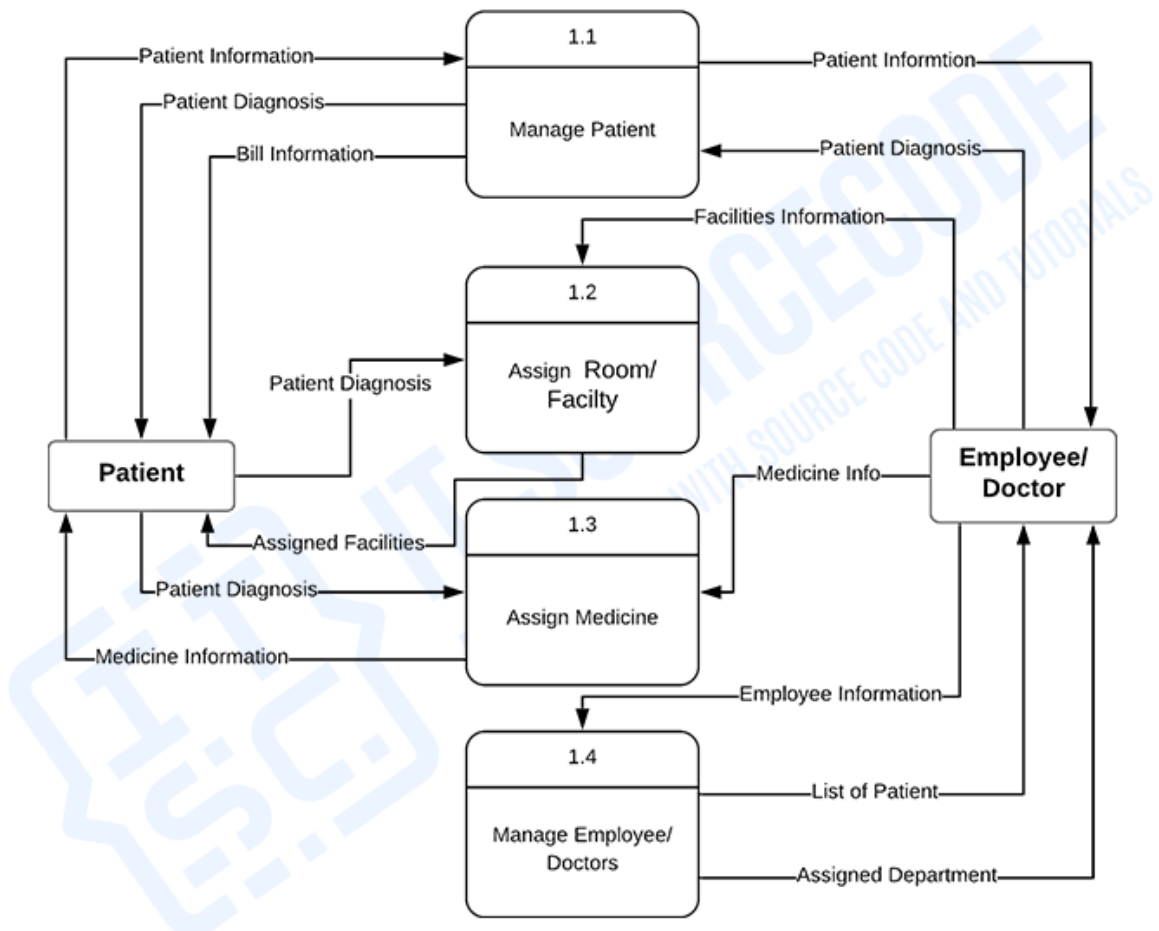

*Hospital Management System DFD Level 1*

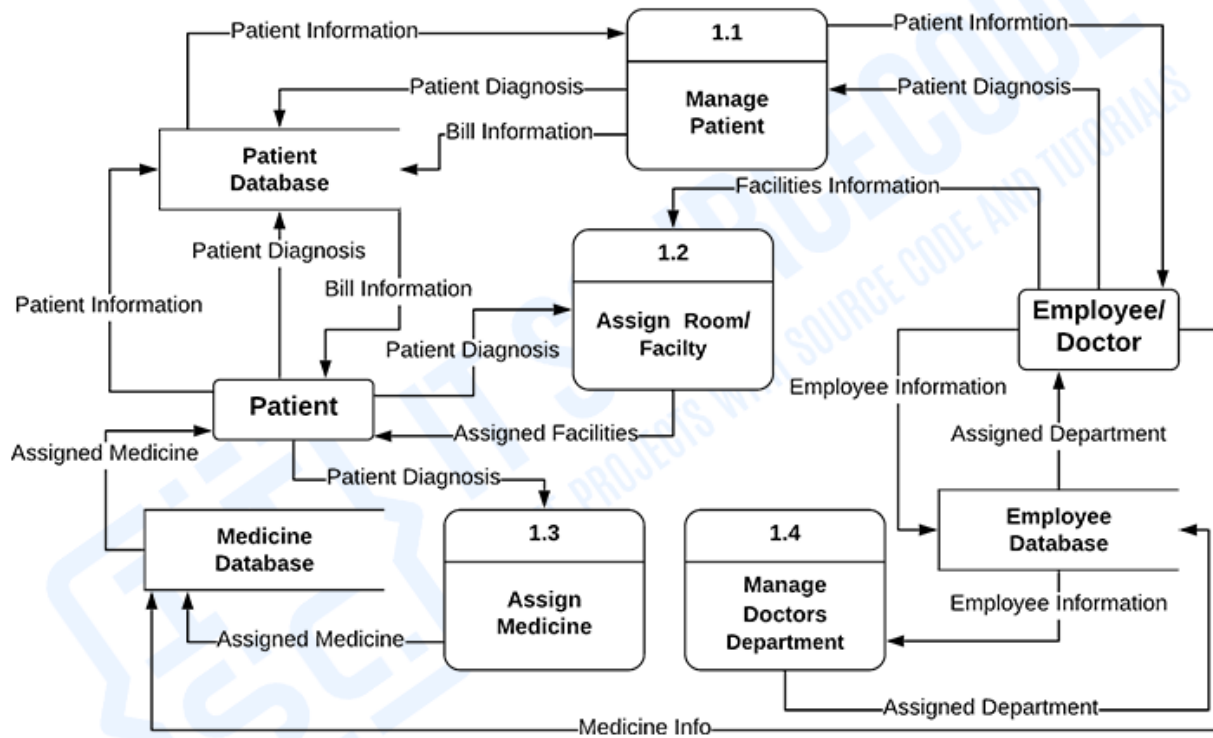

*Hospital Management System DFD Level 2*

[Hospital Management System Class Diagram](#) - is a designed diagram the shows the system's relationships and classes. This UML Class Diagram is made to guide programmers along with the hospital management system development.

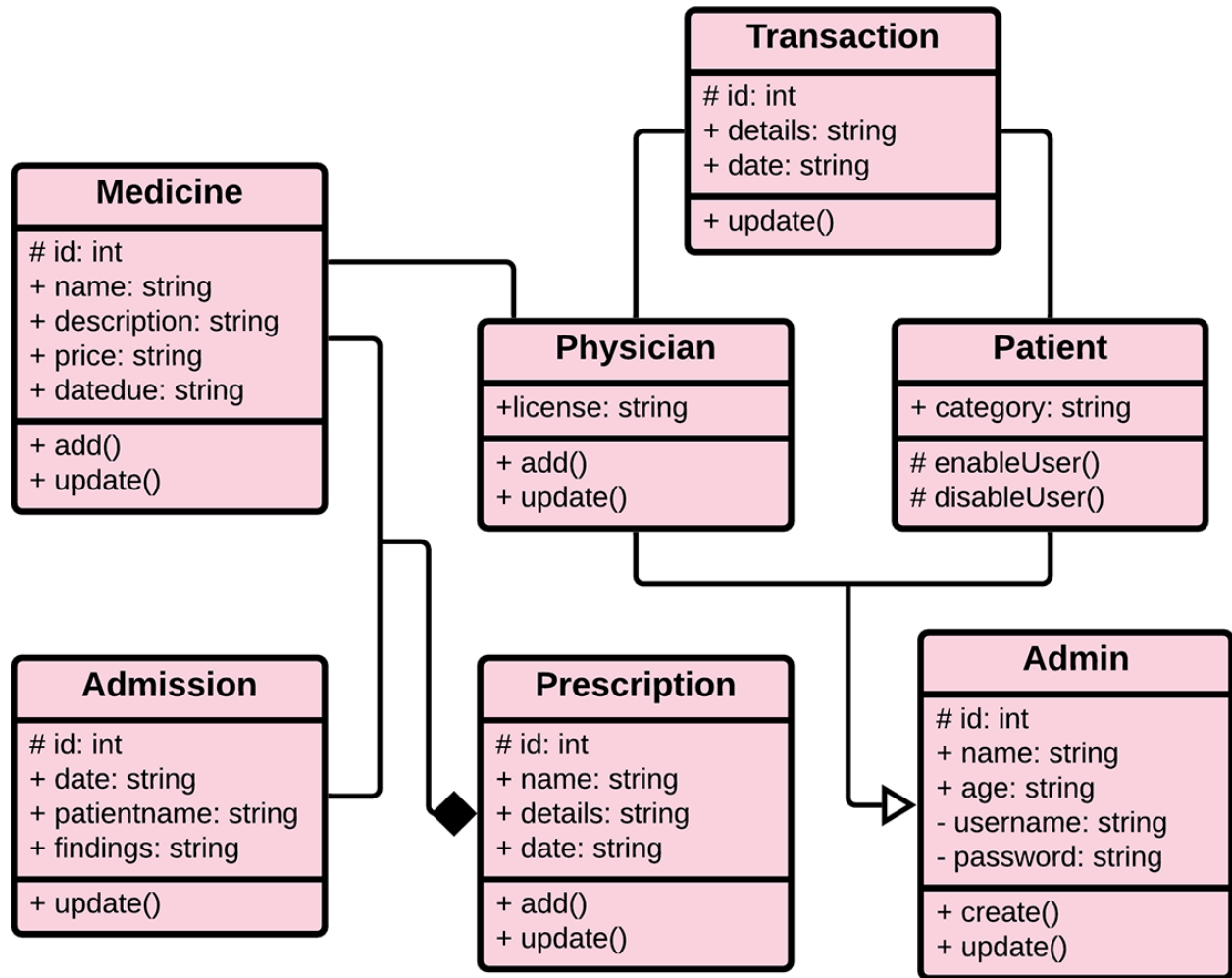

*Hospital Management System Class Diagram*

It contains the class attributes, methods as well as the relationships between classes. These mentioned contents make sure that your Hospital management system development must inline with what should be its functions.



Hospital Management System Sequence Diagram - shows the sequence of events that should be present in the Hospital Management.

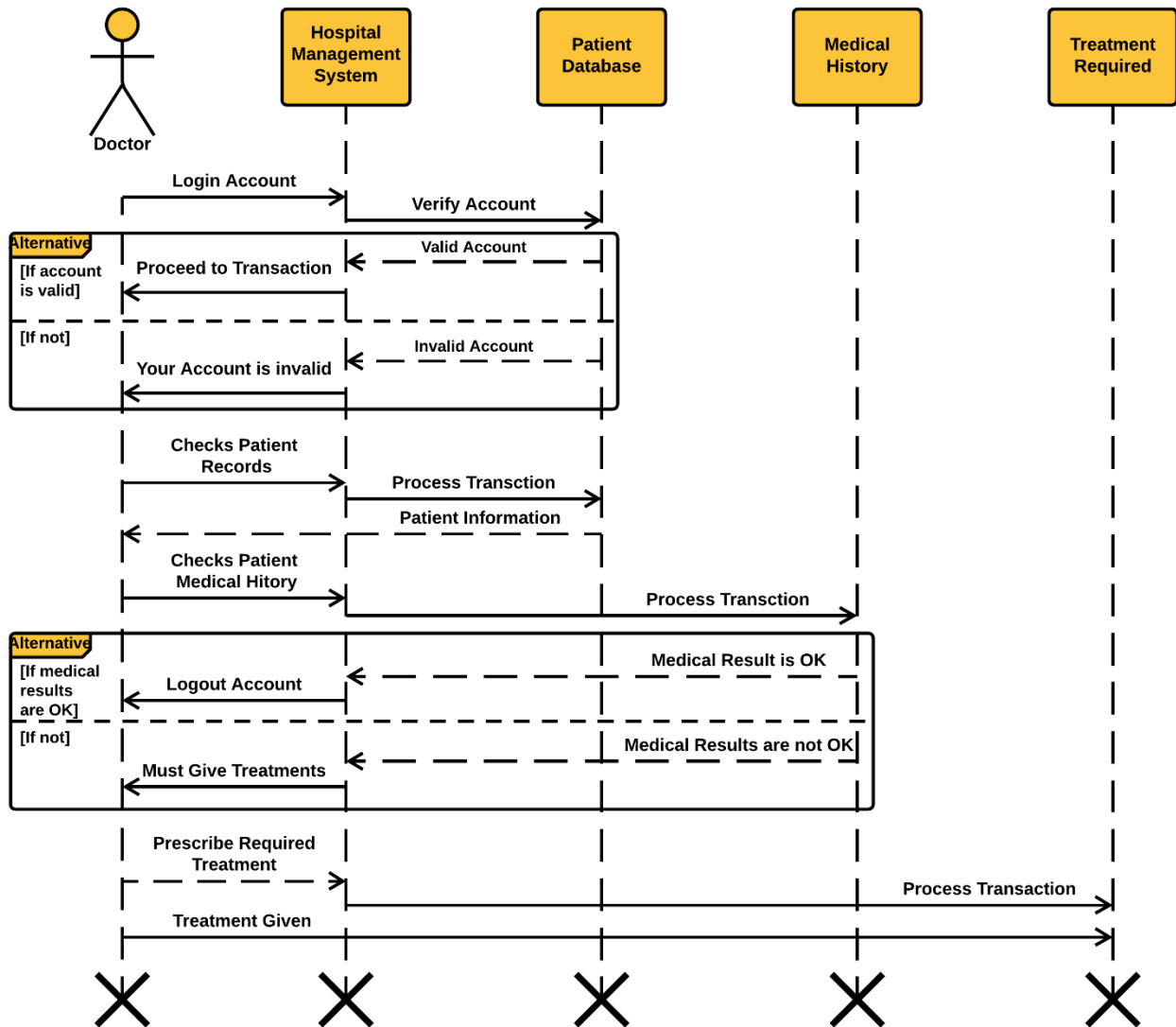

*Hospital Management System Sequence Diagram*

This diagram gives enlightenment and guide to the programmers and developers on how should they build the system. The idea presented in a sequence diagram will give efficiency to Hospital Management system development.

[Hospital Management System Activity Diagram](#) - is one of the UML diagrams built to give the proponents the right ideas on how to develop the said software.

# HOSPITAL MANAGEMENT SYSTEM

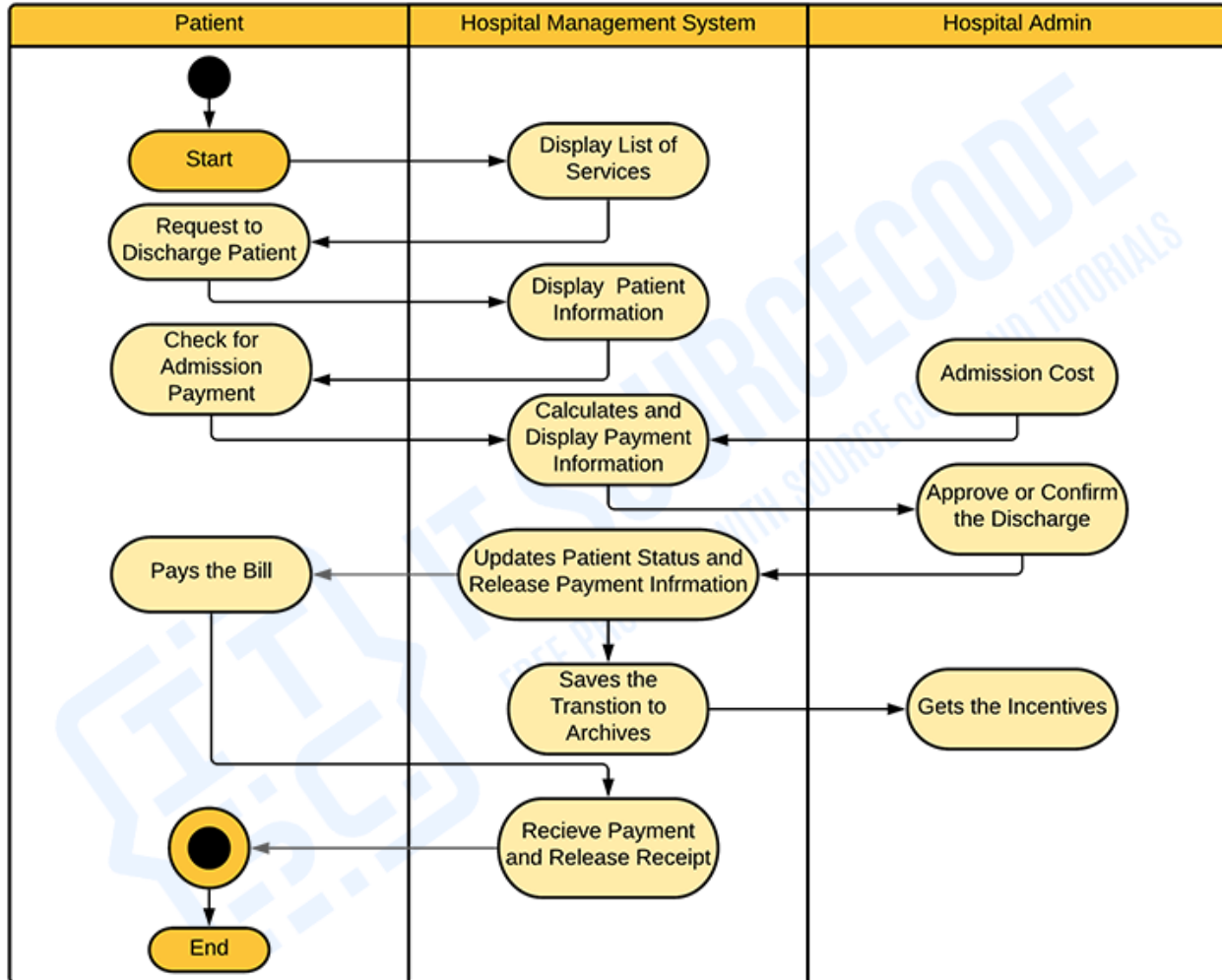

## ACTIVITY DIAGRAM

*Hospital Management System Activity Diagram*